

# ARO®

## AIRLINE ACCESSORIES

FEATURING PRODUCTS FOR AIR PREPARATION



# Airline Accessories

Featuring products for air preparation, including FRLs, hoses, couplings and plugs.

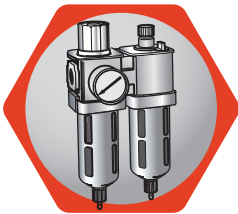

**3-11**

**ARO-Flo Series  
Filters, Regulators,  
Lubricators**

**12-13**

**Super Duty Series  
Filters, Regulators,  
Lubricators**

**14**

**Special Airline  
Products**

**15**

**Fittings & Valves**

**16-17**

**Quick Release  
Couplings  
& Nipples**

**18-19**

**Hoses, Mufflers  
& Blow Guns**



# ARO-Flo Series Air Filters, Regulators & Lubricators

## ARO-Flo Series

For more than 100 years, Ingersoll Rand has been an industry leader in the design and manufacture of compressors, pneumatic tools, and air preparation equipment.

Clean air is a key ingredient that enables effective and efficient operation of tools and machinery. The use of air preparation devices, such as filters, regulators and lubricators is an excellent way of keeping your tools and equipment to operate at their peak performance.

The new ARO-Flo Series continue the tradition of offering premium products for your operating.

### Performance

ARO-Flo Series FRLs set the standard for flow performance. Simply put, air flows better through ARO-Flo filters, regulators, and lubricators than almost any other air filtration device. This means more air is passed during the air preparation process, and your equipment can perform at its peak performance.

### Modularity

All ARO-Flo accessories are designed to integrate with each other within each size range. From pipe adapters to T-brackets, your complete FRL assembly and its individual components can be easily, safely, and quickly assembled or disassembled with a minimum of tools — no fuss or complications, even with fixed piping.

### Safety

Providing safe tools and equipment is our top priority. ARO-Flo Series FRLs are designed with integrated safety features such as locking bowls and clear markings. Accessories such as lockout valves, check valves, and soft-start valves allow the air supply to be safely managed and controlled.

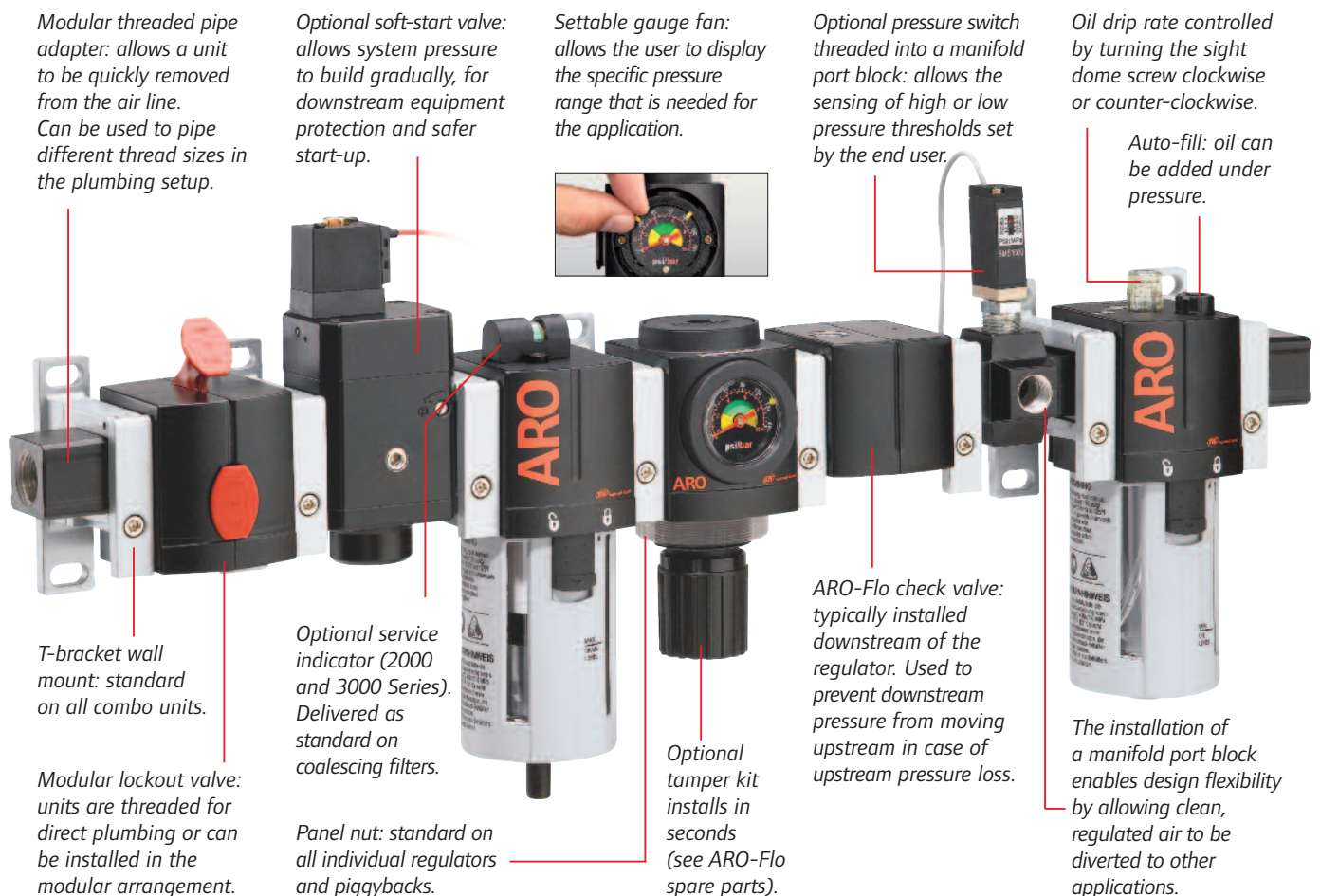

# ARO-Flo Series Air Filters, Regulators & Lubricators

## Installation

For best performance the flow required for your tool or equipment shall be matched with ARO-Flo capacity. When installing FRL observe the order shown in the illustration.

Individual take-off lines to the FRL should be from the top of the compressed air supply line. Observe air flow direction marks on FRLs.

To trap and expel water and contaminants, drip leg drains should be installed at low points in air distribution system and at its far end. If a coalescing filter is required, it should be installed downstream from a standard filter.

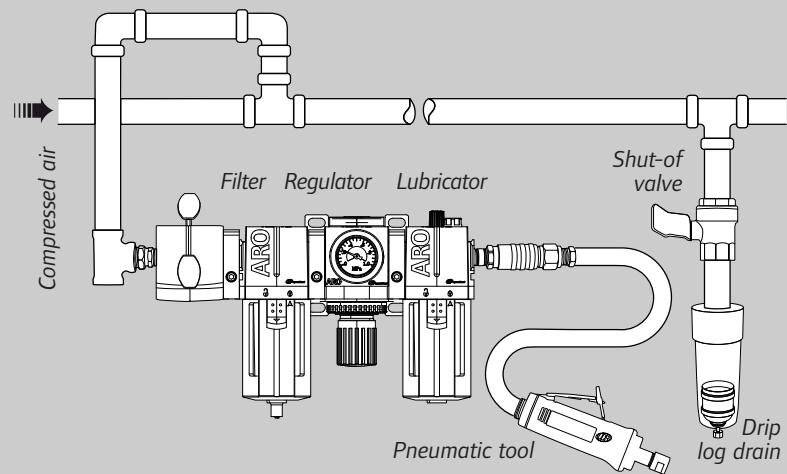

## Flow Capacities in l/min (scfm)<sup>(1)</sup>

Series	Port Size	Filter	Coalescing filter	Regulator	Lubricator	Piggyback
1000	1/8"	1070 (38)	480 (17)	1270 (45)	900 (32)	1210 (43)
	1/4"	1380 (49)	650 (23)	1670 (59)	1440 (51)	1330 (47)
1500	1/4"	2060 (73)	960 (34)	2430 (86)	1440 (51)	2040 (72)
	3/8"	3030 (107)	1410 (50)	3200 (113)	2970 (105)	2550 (90)
2000	3/8"	4420 (156)	2010 (71)	5070 (179)	2400 (85)	3740 (132)
	1/2"	5580 (197)	2600 (92)	5940 (210)	4420 (156)	4770 (172)
	3/4"	6110 (216)	2860 (101)	5940 (210)	6280 (222)	4900 (173)
3000	3/4"	8150 (288)	3740 (132)	8210 (290)	9340 (330)	6680 (236)
	1"	9990 (353)	3960 (140)	8210 (290)	9340 (330)	7080 (250)

(1) **Filter:** at 6.2 bar (90 psig) inlet, and 0.7 bar (10 psig) pressure drop.

**Lubricator:** at 6.2 bar (90 psig) inlet and 0.5 bar (7 psig) pressure drop.

**Regulator and Piggyback:** at 6.9 bar (100 psig) inlet, 6.2 bar (90 psig) set pressure and 2.3 bar (33 psig) pressure drop.

## Bowl Capacities in ml

Series	FILTERS, COALESCING FILTERS and PIGGYBACKS <sup>(2)</sup>				LUBRICATORS	
	Polycarbonate bowl <sup>(3)</sup>		Metal bowl		Polycarbonate bowl <sup>(3)</sup>	Metal bowl
	Manual drain	Auto drain	Manual drain	Auto drain		
1000	14 (9)	20 (14)	13 (9)	21 (14)	17	21
1500	36	31	37	30	56	43
2000	57	68	72	83	128	110
3000	—	—	156 (138)	174 (154)	—	110

(2) Numbers in brackets are given for coalescing filters only.

(3) Some compressor oils, chemical cleaners, solvents, paints, and their fumes can attack polycarbonate and cause bowl failure. See instruction manual for details.

## Temperature Range & Maximum Inlet Pressure

Series	Temperature range	Maximum pressure
Polycarbonate bowl	-5 to 52° C	10.3 bar (150 psig)
Metal bowl	-5 to 79° C	17.2 bar (250 psig)
Regulator	-5 to 60° C	17.2 bar (250 psig)



ARO-Flo Series equipment is exempt from the EU Directives 2002/95/EC (CE compliance), and 94/9/EC (ATEX 95). ARO-Flo Series is Silicon free and meets 2002/95/EC (RoHS compliance).

# ARO-Flo Series Air Filters, Regulators & Lubricators

## ARO-Flo Filters

ARO-Flo compressed air filters are designed to remove airborne solid and liquid contaminants which may plug small orifices and hinder performance, or cause excessive wear and premature equipment failure. Standard filters are supplied with 5-micron elements. 40-micron elements can be purchased and installed separately. Coalescing models are capable of removing oil aerosols and particles down to 0.3 micron. All filters have aluminium body, nitrile seals and acetal baffle. Drain: brass + nitrile (manual), acetal (automatic). Filter insert from Polyethylene (or HEPA paper + felt for coalescing).



Part no.	Series		Max. flow (l/min)	Bowl material and drain type
<b>Standard Air Filters</b>				
F351B1-400	1000	1/4" BSP	1 380	Polycarbonate / Manual
F351B1-421				Metal / Automatic
F352C1-400	1500	3/8" BSP	3 030	Polycarbonate / Manual
F352C1-411				Metal / Automatic
F353D1-400	2000	1/2" BSP	5 580	Polycarbonate / Manual
F353D1-411				Metal / Automatic
F353E1-400		3/4" BSP	6 110	Polycarbonate / Manual
F353E1-411				Metal / Automatic
F354E1-410	3000	3/4" BSP	8 150	Metal / Manual
F354F1-410		1" BSP	9 990	Metal / Manual
<b>Coalescing Air Filters with Service Indicator</b>				
F353D2-311	2000	1/2" BSP	2 600	Metal / Automatic
F354E2-311	3000	3/4" BSP	3 740	Metal / Automatic
F354F2-311		1" BSP	3 960	Metal / Automatic

**F 3 5 3 D 1 - 4 0 0**

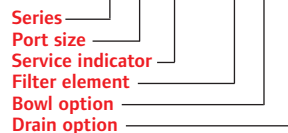

Models not listed in the table are available on special request. Not all combinations available.

- Series**  
 1 = 1000 Series    2 = 1500 Series  
 3 = 2000 Series    4 = 3000 Series
- Port size**  
 1 = 1/8" NPT    A = 1/8" BSP  
 2 = 1/4" NPT    B = 1/4" BSP  
 3 = 3/8" NPT    C = 3/8" BSP  
 4 = 1/2" NPT    D = 1/2" BSP  
 5 = 3/4" NPT    E = 3/4" BSP  
 6 = 1" NPT      F = 1" BSP
- Service indicator**  
 1 = None  
 2 = Mechanical (for coalescing) for 2000 & 3000 Series only

- Filter element**  
 3 = 0.3 micron coalescing  
 4 = 5 micron
- Bowl option**  
 0 = Polycarbonate with guard (without guard on 1000 Series)  
 1 = Metal with sight glass (not available on 1000 Series)  
 2 = Metal without sight glass
- Drain option**  
 0 = Manual  
 1 = Automatic

## ARO-Flo Regulators

ARO-Flo regulators provide controlled, consistent air pressure as required for pneumatic equipment. Rigid aluminium body with nitrile O-rings, acetal knob, steel springs, nylon/polycarbonate gauge cover and 1/8" gauge port. Diaphragm: Nitrile + nylon (nitrile + acetal for Series 1000). Regulator valve: Nitrile + nylon (brass + nitrile for Series 1000). Panel nut included with regulator.



Alternative springs are offered to suit different pressure requirements (see page 8). Non-relieving regulators can be offered if venting of downstream overpressure is undesirable. Please use service kits listed on accessories / spare parts page to convert from relieving to non-relieving models.

Part no.	Series		Max. flow (l/min)	Pressure range
<b>Standard Air Regulators</b>				
R371B1-600	1000	1/4" BSP	1670	0 - 9.6 bar (0 - 140 psig) Max. inlet pressure 17.2 bar (250 psig)
R372C1-600	1500	3/8" BSP	3200	
R373D1-600	2000	1/2" BSP	5940	
R373E1-600		3/4" BSP	5940	
R374E1-600	3000	3/4" BSP	8210	
R374F1-600		1" BSP	8210	

**R 3 7 3 D 1 - 6 0 0**

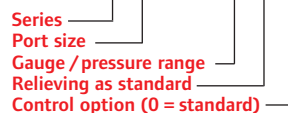

Models not listed in the table are available on special request. Not all combinations available.

- Series**  
 1 = 1000 Series    2 = 1500 Series  
 3 = 2000 Series    4 = 3000 Series
- Port size**  
 1 = 1/8" NPT    A = 1/8" BSP  
 2 = 1/4" NPT    B = 1/4" BSP  
 3 = 3/8" NPT    C = 3/8" BSP  
 4 = 1/2" NPT    D = 1/2" BSP  
 5 = 3/4" NPT    E = 3/4" BSP  
 6 = 1" NPT      F = 1" BSP

- Gauge / pressure range**  
 1 = 0 - 9.6 bar (0 - 140 psig) no gauge.  
 2 = 0 - 4 bar (0 - 60 psig) no gauge.  
 3 = 0.7 - 14 bar (10 - 200 psig) no gauge, on 2000 & 3000 Series only.  
 4 = 0 - 2 bar (0 - 30 psig) no gauge.  
 6 = 0 - 9.6 bar (0 - 140 psig) with flush mount gauge = standard.

# ARO-Flo Series Air Filters, Regulators & Lubricators

## ARO-Flo Lubricators

ARO-Flo mist-type lubricators are designed to provide the correct amount of oil required for most general applications in a pneumatic system, delivering a constant ratio of oil to air flow. Precise oil feed adjustment sets the proper oil drip rate.

Lubricators should be installed close to the downstream application to ensure effective distribution of oil. All lubricators are with aluminium body, nitrile seals, nylon sight dome and urethane inlet tube.

Oil refill can be done under pressure.



Part no.	Series		Max. flow (l/min)	Bowl material
<b>Standard Air Lubricators</b>				
L361B1-100	1000	1/4" BSP	1440	Polycarbonate
L361B1-120				Metal
L362C1-100	1500	3/8" BSP	2970	Polycarbonate
L362C1-110				Metal
L363D1-100	2000	1/2" BSP	4420	Polycarbonate
L363D1-110				Metal
L363E1-100		3/4" BSP	6280	Polycarbonate
L363E1-110				Metal
L364F1-110	3000	1" BSP	9340	Metal

**L 3 6 3 D 1 - 1 0 0**

Series  
Port size  
Adjustment option (1 = std.)  
Bowl option  
Fill option (0 = std.)

Models not listed in the table are available on special request. Not all combinations available.

**Series**  
1 = 1000 Series 2 = 1500 Series  
3 = 2000 Series 4 = 3000 Series

**Port size**  
1 = 1/8" NPT A = 1/8" BSP  
2 = 1/4" NPT B = 1/4" BSP  
3 = 3/8" NPT C = 3/8" BSP  
4 = 1/2" NPT D = 1/2" BSP  
5 = 3/4" NPT E = 3/4" BSP  
6 = 1" NPT F = 1" BSP

**Bowl option**  
0 = Polycarbonate with guard (without guard on 1000 Series)  
1 = Metal with sight glass (not available on 1000 Series)  
2 = Metal without sight glass

## ARO-Flo Piggybacks

"Piggybacks" combine the functions of both a filter and regulator. Piggybacks are compact and most effective when space is a constraint.

They can be ordered with different filter elements and can be modified with different springs, depending on the filtration and air regulating requirements (see accessories page 8).

Delivered as standard with panel nut.



Part no.	Series		Max. flow (l/min)	Bowl material and drain type
<b>Standard Piggybacks</b>				
P391B4-600	1000	1/4" BSP	1330	Polycarbonate / Manual
P391B4-624				Metal / Automatic
P392C4-600	1500	3/8" BSP	2550	Polycarbonate / Manual
P392C4-614				Metal / Automatic
P393D4-600	2000	1/2" BSP	4770	Polycarbonate / Manual
P393D4-614				Metal / Automatic
P393E4-600		3/4" BSP	4900	Polycarbonate / Manual
P393E4-614				Metal / Automatic
P394F4-610	3000	1" BSP	7080	Metal / Manual

**P 3 9 3 D 4 - 6 0 0**

Series  
Port size  
Filter element (4 = std. 5µ)  
Gauge (6 = std.)  
Bowl option  
Drain option

Models not listed in the table are available on special request. Not all combinations available.

**Series**  
1 = 1000 Series 2 = 1500 Series  
3 = 2000 Series 4 = 3000 Series

**Port size**  
1 = 1/8" NPT A = 1/8" BSP  
2 = 1/4" NPT B = 1/4" BSP  
3 = 3/8" NPT C = 3/8" BSP  
4 = 1/2" NPT D = 1/2" BSP  
5 = 3/4" NPT E = 3/4" BSP  
6 = 1" NPT F = 1" BSP

**Bowl option**  
0 = Polycarbonate with guard (without guard on 1000 Series)  
1 = Metal with sight glass (not available on 1000 Series)  
2 = Metal without sight glass

**Drain option**  
0 = Manual  
4 = Automatic

# ARO-Flo Series Air Filters, Regulators & Lubricators

## ARO-Flo 2 and 3 Piece Combination Units

Filters, regulators, lubricators and piggybacks can be combined together. They are typically strung together in the F+R+L arrangement (three-piece combo) and F/R+L (two-piece combo) arrangement, although other configurations are also used depending on application needs.

All ARO-Flo Combinations have a 5 micron filter element and a relieving regulator 0-9.6 bar (0-140 psig) with flush mount gauge. They are supplied assembled with modular T-shape wall mount bracket kits. The panel nuts are not included with units. They must be ordered separately if needed.

- Standard 2-pieces combo includes polycarbonate bowls with sight glass (except 3000 Series with metal bowls / sight glass) and manual drain.
- Standard 3-pieces combo includes metal bowls with sight glass (except 1000 Series, no sight glass) and automatic drain.



Part no.	Series		Max. flow (l/min)	Bowl material and drain type
<b>2-piece Combined Units (F/R + L)</b>				
C381B1-600	1000	1/4" BSP	1240	Polycarbonate / Manual
C382C1-600	1500	3/8" BSP	2010	Polycarbonate / Manual
C383D1-600	2000	1/2" BSP	3400	Polycarbonate / Manual
C383E1-600		3/4" BSP	4020	Polycarbonate / Manual
C384F1-610	3000	1" BSP	5890	Metal / Manual
<b>3-piece Combined Units (F + R + L)</b>				
C381B1-821	1000	1/4" BSP	1300	Metal / Automatic
C382C1-811	1500	3/8" BSP	2400	Metal / Automatic
C383D1-811	2000	1/2" BSP	4250	Metal / Automatic
C383E1-811		3/4" BSP	4840	Metal / Automatic
C384F1-811	3000	1" BSP	6090	Metal / Automatic

### C 3 8 3 D 1 - 6 0 0

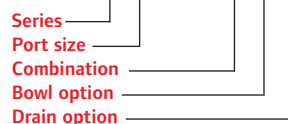

Models not listed in the table are available on special request. Not all combinations available.

**Series**  
 1 = 1000 Series    2 = 1500 Series  
 3 = 2000 Series    4 = 3000 Series

**Port size**  
 1 = 1/8" NPT    A = 1/8" BSP  
 2 = 1/4" NPT    B = 1/4" BSP  
 3 = 3/8" NPT    C = 3/8" BSP  
 4 = 1/2" NPT    D = 1/2" BSP  
 5 = 3/4" NPT    E = 3/4" BSP  
 6 = 1" NPT      F = 1" BSP

**Combination**  
 6 = Filter/Regulator + Lubricator  
 8 = Filter+ Regulator + Lubricator

**Bowl option**  
 0 = Polycarbonate with guard (without guard on 1000 Series)  
 1 = Metal with sight glass (not available on 1000 Series)  
 2 = Metal without sight glass

**Drain option**  
 0 = Manual  
 1 = Automatic

# ARO-Flo Series Air Filters, Regulators & Lubricators

## ARO-Flo Series Accessories

Description	1000Series	1500Series	2000Series	3000Series
Lock-out valve (BSP)	104390-B (1/4")	104391-C (3/8")	104392-D (1/2")	104393-F (1")
2 threaded pipe adapters (BSP)	104474-B (1/4")	104475-C (3/8")	104398-D (1/2")	104476-F (1")
Check valve (NPT)	104477-2 (1/4")	104478-2 (1/4")	104479-3 (3/8")	—
Threaded manifold block (NPT)	104411-1-1 (1/4" x 1/8")	104412-3-1 (3/8" x 3/8")	104413-4-2 (1/2" x 1/4")	—
	104411-2-2 (1/4" x 1/4")	104412-3-2 (3/8" x 1/4")	104413-4-3 (1/2" x 3/8")	—
Modular clamp spacer kit	104394	104395	104396 <sup>(1)</sup>	104397
T-type wall mount bracket / spacer	104399	104400	104401 <sup>(1)</sup>	104402
C-type wall mount bracket	—	—	104409	104410
L-type wall mount bracket (for piggyback)	104403	104404	104405	104406
Panel nut (for L-bracket)	104416	104417	104418	104419
Pressure sensor (connects to 1/8" port)	104415	104415	104415	—
Gauge port block, 1/8" NPT <sup>(2)</sup>	104467	104467	104469	104469
24VDC soft start valve, 1/2" BSP	—	—	SSV3D3-024-D	—
240V AC soft start valve, 1/2" BSP	—	—	SSV3D3-240A	—

(1) For series 2000 with 3/4" thread, use modular clamp 104397 or T-type wall mount bracket /spacer 104402.

(2) Optional Ø 1.5" (38 mm) face mount gauge with polycarbonate lens and NPT 1/8" thread: part no. 104493: 0-11 bar (0-160 psig) – part no. 104492: 0-5 bar (0-75 psig) – part no. 104491: 0-3 bar (0-45 psig).

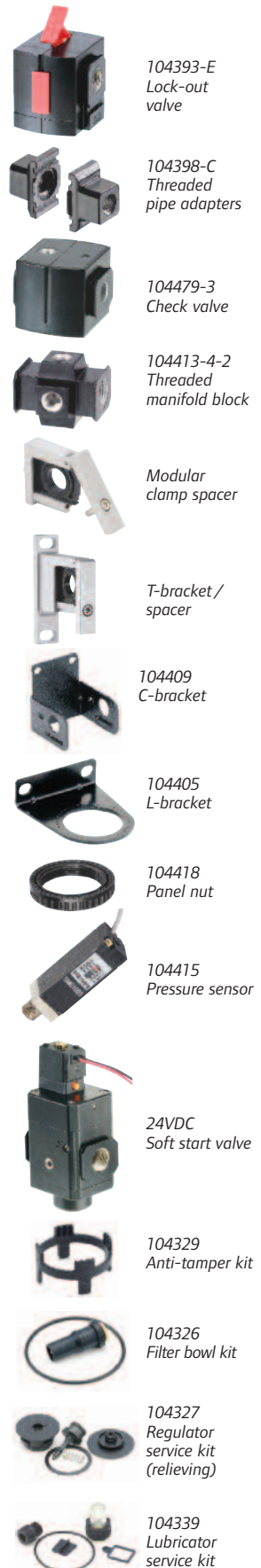

## ARO-Flo Series Spare Parts

Description	1000Series	1500Series	2000Series	3000Series
<b>Filter</b>				
Automatic drain	104293	104315	104315	104315
Manual drain kit (contains bowl O-ring)	104468	104429	104326	104452
5 micron element	104295	104422	104317	104445
40 micron element	104296	104423	104318	104446
0.3 micron element for standard bowl	—	104424	104319	—
Polycarbonate bowl with manual drain	104298	104425	104320	—
Polycarbonate bowl with auto drain	104299	104426	104321	—
Metal bowl with sight glass & manual drain	104300 <sup>(3)</sup>	104481	104325	104450
Metal bowl with sight glass & auto drain	104301 <sup>(3)</sup>	104482	104324	104451
Coalescing filter bowl with manual drain	104459	—	—	104461
Coalescing filter bowl with auto drain	104460	—	—	104462
0.3 micron element for coalescing bowl	104297	—	—	104447
<b>Regulator</b>				
Regulator service kit (relieving)	104302	104430	104327	104453
Regulator service kit (non-relieving)	104303	104431	104328	104454
Anti-tamper kit	104304	104432	104329	104455
Spring 0-2 bar (0-30 psig)	104305	104433	—	—
Spring 0-4.1 bar (0-60 psig)	104306	104434	104330	104456
Spring 0-9.6 bar (0-140 psig)	104307	104435	104331	104457
Gauge 0-9.6 bar (0-140 psig), flush-mount	104310	104310	104334	104334
Spring 0.7-13.8 bar (10-200 psig)	—	—	104332	104458
<b>Lubricator</b>				
Lubricator polycarbonate bowl with guard	104311	104439	104336	—
Lubricator metal bowl with sight glass	104312 <sup>(3)</sup>	104440	104338	104338
Lubricator service kit	104313	104441	104339	104465
Sight dome repair kit (incl. inner dome)	104314	104442	104470	104466

(3) Sight glass is not supplied with the 1000 Series.



# ARO-Flo Series Air Filters, Regulators & Lubricators

## ARO-Flo Series Dimensions

Product	Part no.	Series	Dimensions (mm)				
			A	B	C	D	E
FILTERS	F351B1-400	1000	110	40	46	20	90
	F351B1-421		127	40	46	20	107
	F352C1-400	1500	157	56	57	25	132
	F352C1-411		179	56	57	25	154
	F353D1-400	2000	179	70	73	28	151
	F353D1-411		201	70	73	28	173
	F353E1-400		179	76	73	28	151
	F353E1-411	3000	201	76	73	28	173
	F354E1-410		252	90	98	38	214
	F354F1-410		252	90	98	38	214
COALESCING FILTER	F353D2-311	2000	218	70	73	45	173
	F354E2-311	3000	292	90	98	55	237
	F354F2-311		292	90	98	55	237
REGULATOR	R371B1-600	1000	91	40	74	24	67
	R372C1-600	1500	121	56	79	32	89
	R373D1-600	2000	140	70	80	37	103
	R373E1-600		140	70	80	37	103
	R374E1-600	3000	184	90	104	51	133
	R374F1-600		184	90	104	51	133
LUBRICATOR	L361B1-100	1000	128	40	46	42	86
	L361B1-120		128	40	46	42	86
	L362C1-100	1500	152	56	57	45	107
	L362C1-110		152	56	57	45	107
	L363D1-100	2000	180	70	73	43	137
	L363D1-110		182	70	73	43	139
	L363E1-100		180	70	73	43	137
	L363E1-110	3000	182	70	73	43	139
L364F1-110	257		90	98	55	202	
PIGGYBACK	P391B4-600	1000	157	40	74	67	90
	P391B4-624		175	40	74	67	108
	P392C4-600	1500	207	56	79	86	121
	P392C4-614		229	56	79	86	143
	P393D4-600	2000	253	70	80	100	153
	P393D4-614		276	70	80	100	176
	P393E4-600		253	70	80	100	153
	P393E4-614	3000	276	70	80	100	176
P394F4-610	347		90	104	133	214	
2-PIECE COMBINED UNIT	C381B1-600	1000	157	80	80	67	90
	C382C1-600	1500	209	112	84	86	123
	C383D1-600	2000	252	145	90	100	152
	C383E1-600		252	145	90	100	152
	C384F1-610	3000	351	186	109	133	218
3-PIECE COMBINED UNIT	C381B1-821	1000	149	120	80	42	107
	C382C1-811	1500	199	168	84	45	154
	C383D1-811	2000	216	221	90	43	173
	C383E1-811		216	221	90	43	173
C384F1-811	3000	292	282	109	55	237	

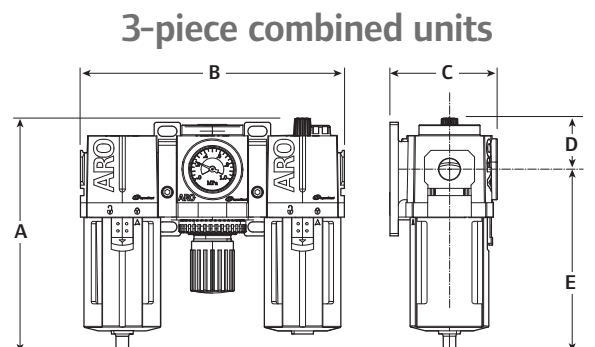
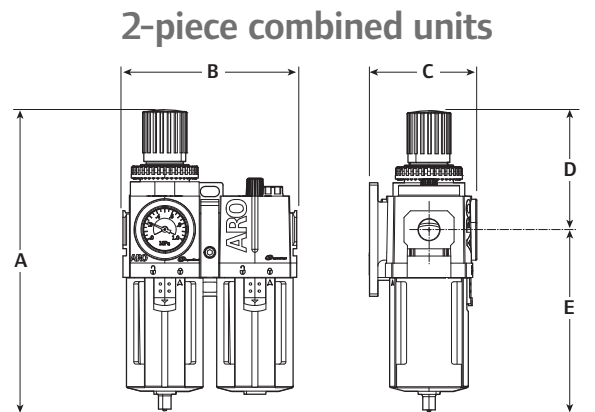
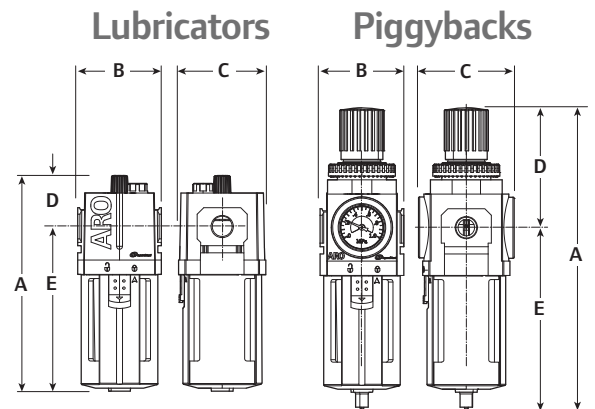
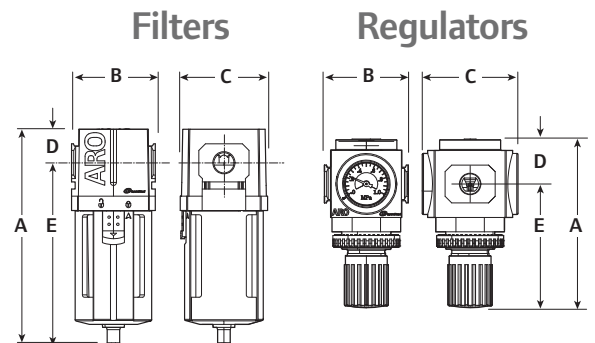

# ARO-Flo Series Air Filters, Regulators & Lubricators

## ARO-Flo Series Flow Charts

### 1000 Series

**Filter 1/4" pressure drop test**

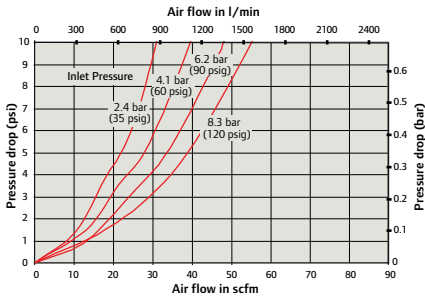

**Regulator 1/4" pressure drop test**

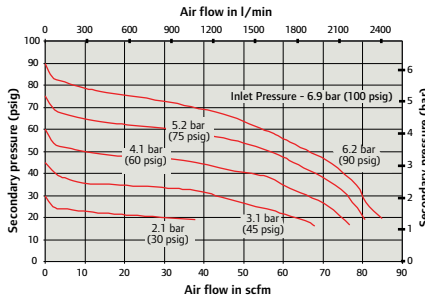

**Lubricator 1/4" pressure drop test**

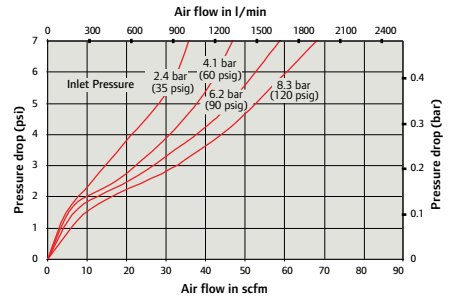

### 1500 Series

**Filter 3/8" pressure drop test**

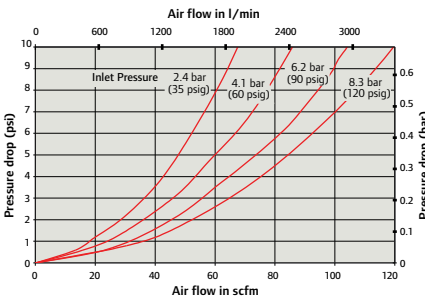

**Regulator 3/8" pressure drop test**

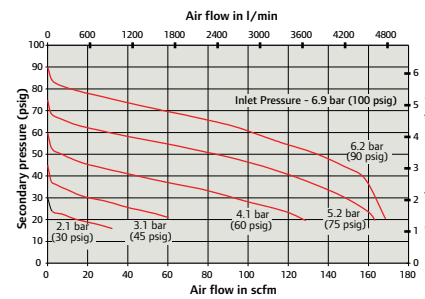

**Lubricator 3/8" pressure drop test**

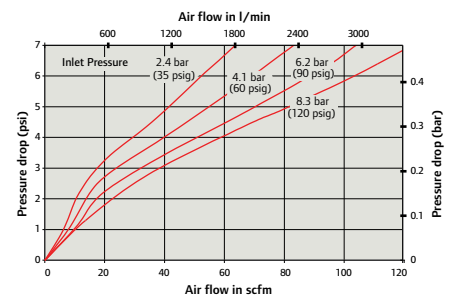

### 2000 Series

**Filter 1/2" & 3/4" pressure drop test**

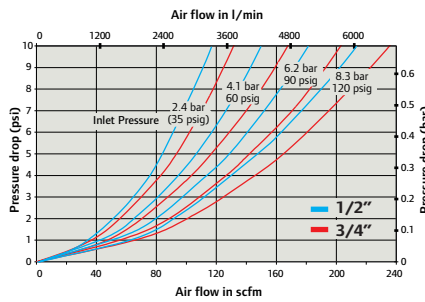

**Regulator 1/2" & 3/4" pressure drop test**

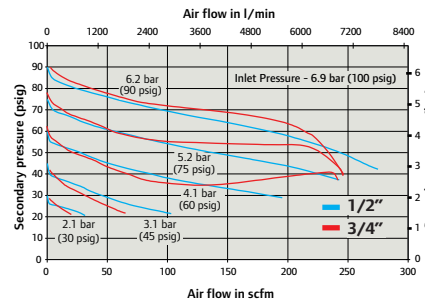

**Lubricator 1/2" & 3/4" pressure drop test**

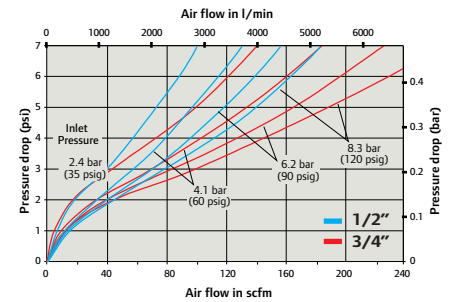

### 3000 Series

**Filter 3/4" & 1" pressure drop test**

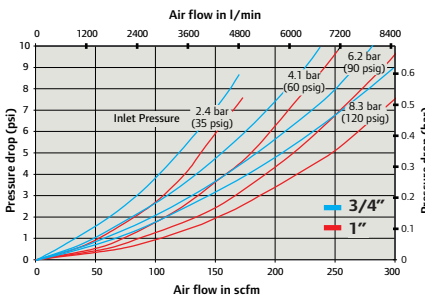

**Regulator 3/4" & 1" pressure drop test**

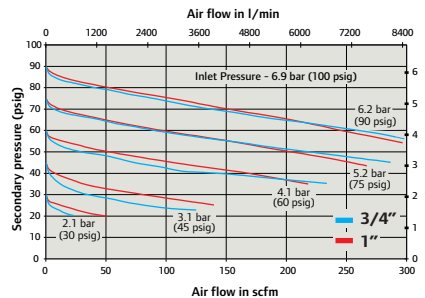

**Lubricator 1" pressure drop test**

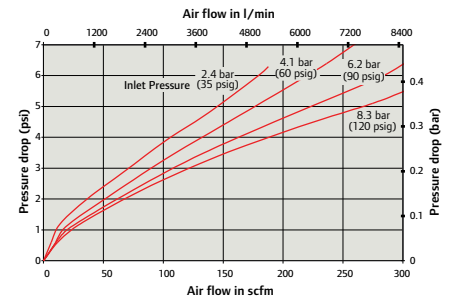

# ARO-Flo Series Air Filters, Regulators & Lubricators

## ARO-Flo Series Flow Charts

### 1000 Series

**Piggyback 1/4" pressure drop test**

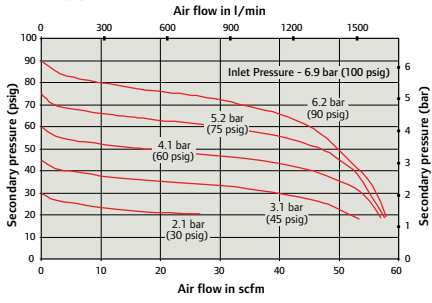

**F/R+L 1/4" pressure drop test**

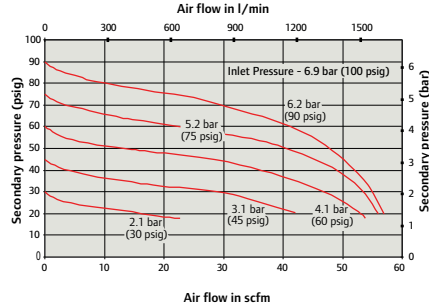

**F+R+L 1/4" pressure drop test**

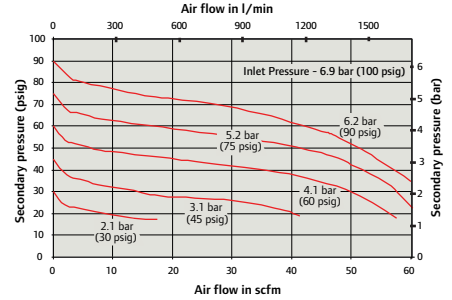

### 1500 Series

**Piggyback 3/8" pressure drop test**

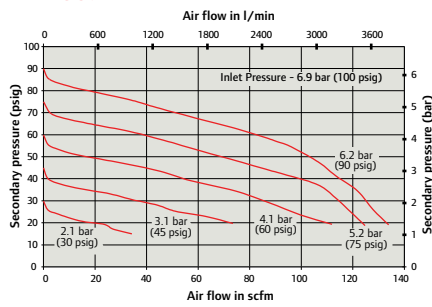

**F/R+L 3/8" pressure drop test**

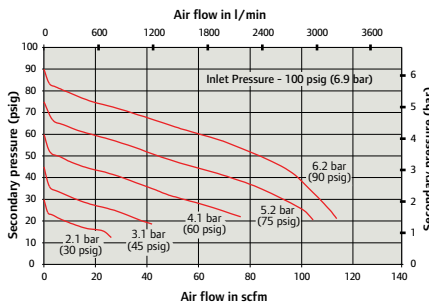

**F+R+L 3/8" pressure drop test**

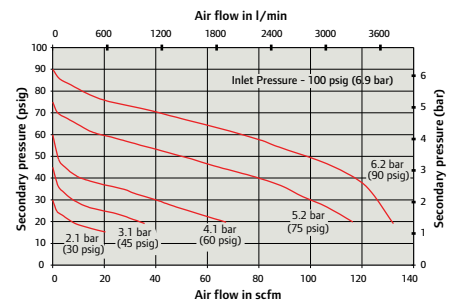

### 2000 Series

**Piggyback 1/2" & 3/4" pres. drop test**

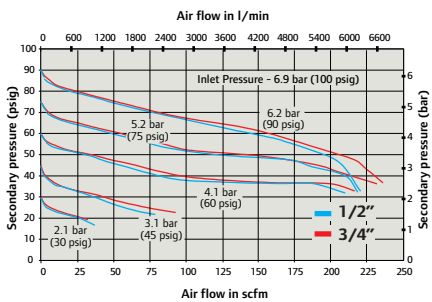

**F/R+L 1/2" & 3/4" pressure drop test**

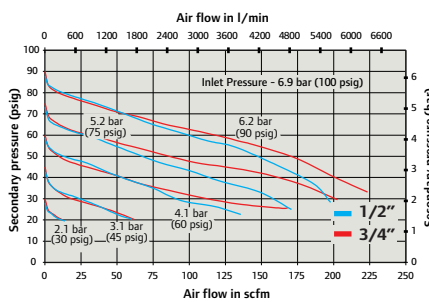

**F+R+L 1/2" & 3/4" pressure drop test**

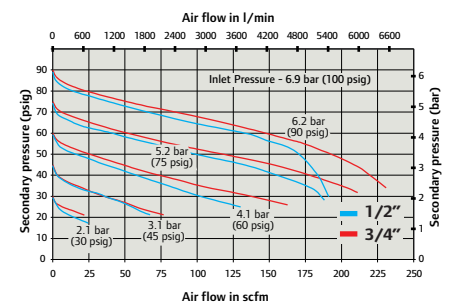

### 3000 Series

**Piggyback 1" pressure drop test**

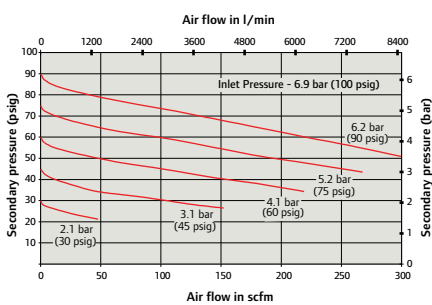

**F/R+L 1" pressure drop test**

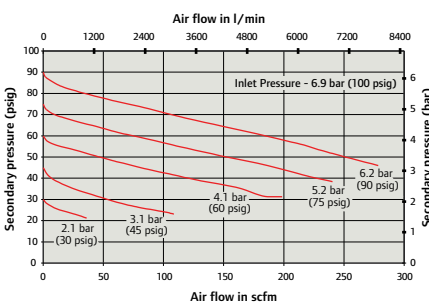

**F+R+L 1" pressure drop test**

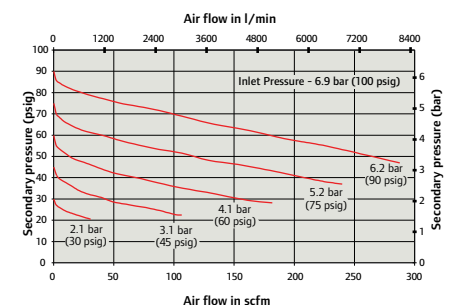

# Super Duty Series Air Filters, Regulators & Lubricators

## Super Duty Filters

- High-flow filter element with 5-micron filtration.
- Differential pressure indicator to eliminate the guesswork of element replacement.
- Robust cast aluminium housings to withstand operating pressures up to 20.7 bar (300 psig). Maximum supply pressure limited to 10.3 bar (150 psig) with pressure indicator.
- All filters have plated steel internal components and fluorocarbon seals. Filter insert from polyethylene/polypropylene.
- Weight: 8.7 kg (all models).

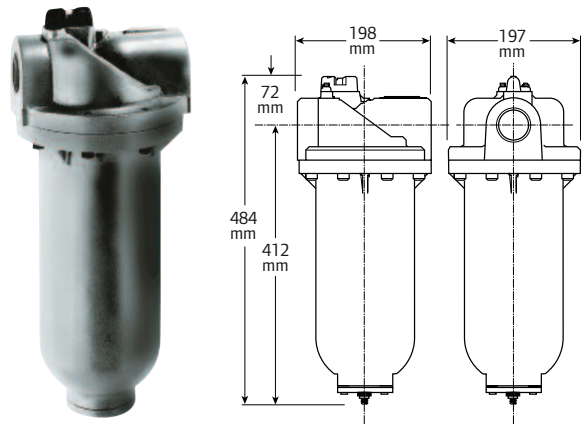

F355H1-411

Part no.		Max. flow (m <sup>3</sup> /min)	Bowl capacity (litre)	Bowl material and drain type
<b>Standard Air Filters</b>				
F355G1-411	1 1/4" BSP	27.5 <sup>(1)</sup>	0.37	Aluminium / Automatic
F355H1-411	1 1/2" BSP	36.2 <sup>(1)</sup>	0.37	Aluminium / Automatic
F355J1-411	2" BSP	39.6 <sup>(1)</sup>	0.37	Aluminium / Automatic
F35571-411	1 1/4" NPT	27.5 <sup>(1)</sup>	0.37	Aluminium / Automatic
F35581-411	1 1/2" NPT	36.2 <sup>(1)</sup>	0.37	Aluminium / Automatic
F35591-411	2" NPT	39.6 <sup>(1)</sup>	0.37	Aluminium / Automatic

(1) At 10.3 bar (150 psig) inlet pressure. Pressure drop of 0.3 bar (5 psig).

Operating temperature: 0 - 65°C.

## Replacement parts

Part no.	Description
104510	5-micron filter insert
104508	Automatic drain

## Super Duty Regulators

- High-flow capacity.
- Balanced valve design for excellent regulation characteristics.
- Maximum inlet pressure 20.7 bar (300 psig).
- Two 1/4" NPT gauge ports as standard for manometer and/or additional outlet port. Gauge to be ordered separately.
- Regulator body, piston and bonnet from zinc. Valve assembly from brass, nitrile and acetal. Nitrile seals.
- Weight: models R375G1-100 and R37571-100: 2.7 kg. Other models: 4.9 kg
- Option 1/4" port gauge, 0-11 bar (0-160 psig), part no. 104502.

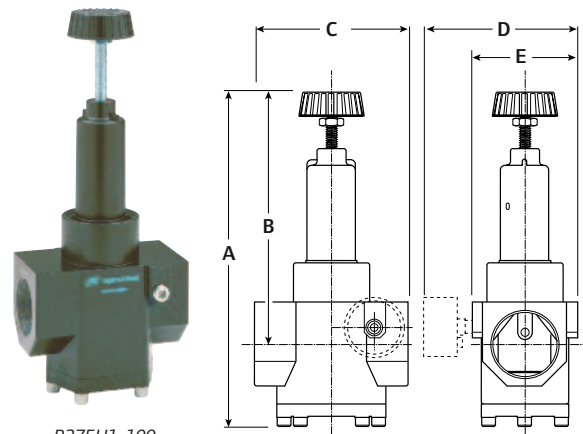

R375H1-100

## Dimensions in mm

Part no.	A	B	C	D	E
R375G1-100 & R37571-100	262	219	109	109	67
R375H1-100 & R37581-100	302	231	135	135	91
R375J1-100 & R37591-100	302	231	135	135	91

Part no.		Max. flow (m <sup>3</sup> /min)	Adjusting pressure range
<b>Standard Air Regulators</b>			
R375G1-100	1 1/4" BSP	22.6 <sup>(2)</sup>	0 - 8.5 bar (0 - 125 psig)
R375H1-100	1 1/2" BSP	34.0 <sup>(3)</sup>	
R375J1-100	2" BSP	34.0 <sup>(3)</sup>	
R37571-100	1 1/4" NPT	22.6 <sup>(2)</sup>	0 - 8.5 bar (0 - 125 psig)
R37581-100	1 1/2" NPT	34.0 <sup>(3)</sup>	
R37591-100	2" NPT	34.0 <sup>(3)</sup>	

(2) At 6.9 bar (100 psig) inlet pressure, secondary pressure of 5.5 bar (80 psig).

(3) At 6.9 bar (100 psig) inlet pressure, secondary pressure of 5.9 bar (85 psig).

Operating temperature: 0 - 65°C.



104502 optional gauge, steel case with glass lens.

# Super duty Series Air Filters, Regulators & Lubricators

## Super Duty Lubricators

- Full view sight dome.
- Siphon tube filter provides clean lubricant downstream.
- Adjustable oil feed.
- Standard transparent bowl with metal bowl guard.
- Can be filled while under pressure – Max 13.8 bar at inlet.
- Lubricator body in zinc. Fluorocarbon seals. Sight dome in nylon.
- L365J1-110 and L36591-110: 4.6 kg. Other models: 4.3 kg.

L365H1-110

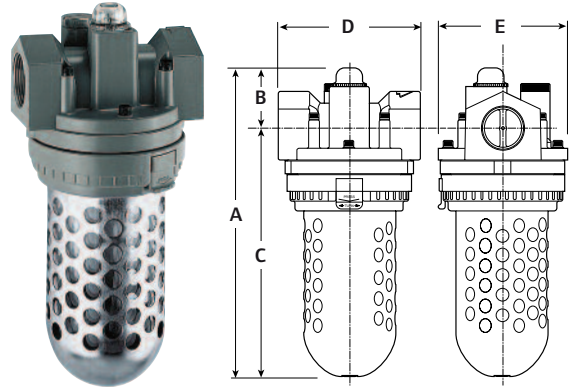

Dimensions in mm

Part no.	A	B	C	D	E
L365G1-110 & L36571-110	295	58	237	140	127
L365H1-110 & L36581-110	295	58	237	140	127
L365J1-110 & L36591-110	311	66	245	140	127

(4) At 8 bar (120 psig) inlet pressure. Pressure drop of 0.3 bar (5 psig)  
Operating temperature: 0 - 65°C.

Part no.	Max. flow (m <sup>3</sup> /min)	Bowl capacity (litre)	Bowl material	
<b>Standard Air Lubricators</b>				
L365G1-110	1 1/4" BSP	26.2 <sup>(4)</sup>	0.77	Metal / Transparent
L365H1-110	1 1/2" BSP	26.2 <sup>(4)</sup>	0.77	Metal / Transparent
L365J1-110	2" BSP	33.6 <sup>(4)</sup>	0.77	Metal / Transparent
L36571-110	1 1/4" NPT	26.2 <sup>(4)</sup>	0.77	Metal / Transparent
L36581-110	1 1/2" NPT	26.2 <sup>(4)</sup>	0.77	Metal / Transparent
L36591-110	2" NPT	33.6 <sup>(4)</sup>	0.77	Metal / Transparent

## Super Duty Series Flow Charts

### 1 1/4" Series

#### Filter 1 1/4" pressure drop test

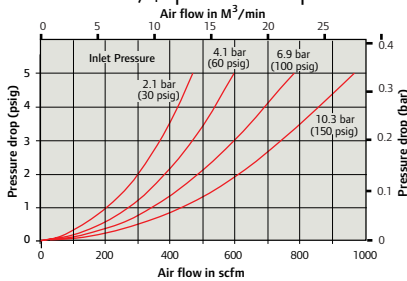

#### Regulator 1 1/4" pressure drop test

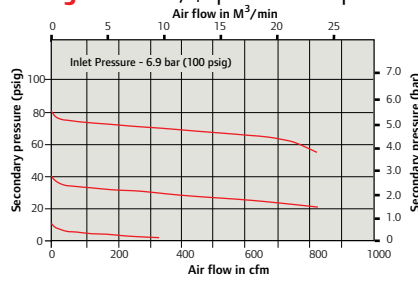

#### Lubricator 1 1/4" pressure drop test

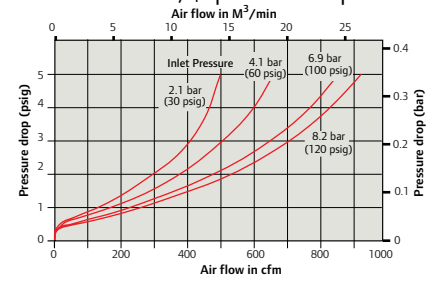

### 1 1/2" Series

#### Filter 1 1/2" pressure drop test

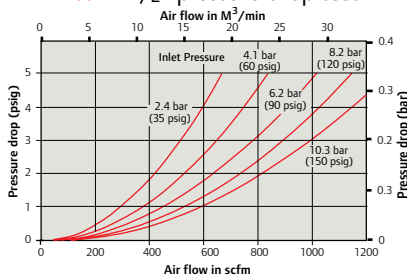

#### Regulator 1 1/2" pressure drop test

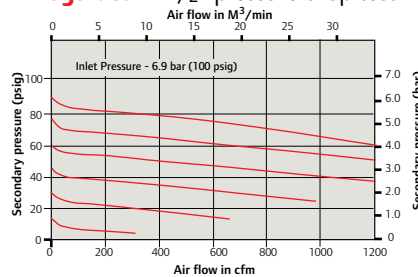

#### Lubricator 1 1/2" pressure drop test

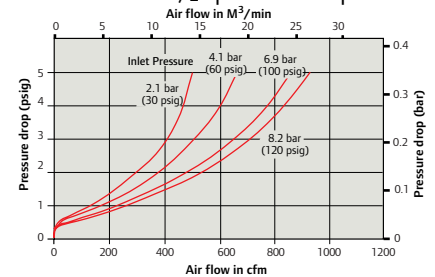

### 2" Series

#### Filter 2" pressure drop test

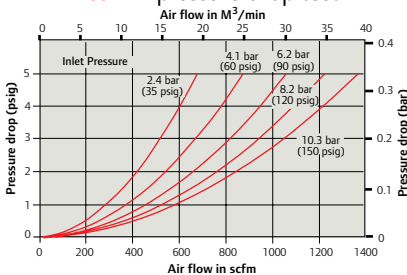

#### Regulator 2" pressure drop test

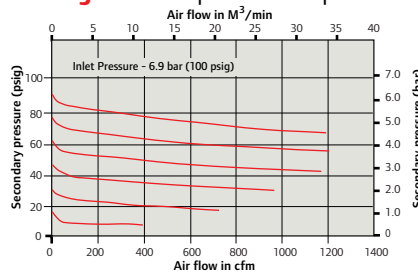

#### Lubricator 2" pressure drop test

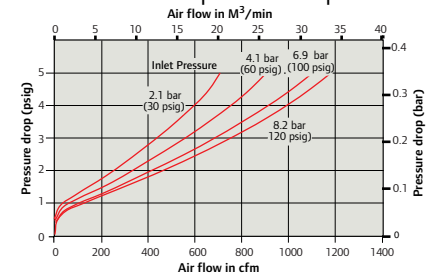

# Special Airline Products

## Dial-Air™ Regulators

These regulators feature a transparent pressure-calibrated, nonrising adjustment dial which allows one to dial any secondary pressure. If a gauge is required for monitoring reasons, two 1/4" gauge ports are provided: however, these are usually used for additional outlet port. In less than 270° turn, the full secondary pressure range can be dialed. This feature is particularly advantageous if secondary pressure must be changed frequently.

- Regulator body and bonnet from zinc. Piston from acetal (R21) or zinc (R31 and 41). Valve assembly from brass, nitrile and acetal. Nitrile seals.
- Maximum inlet pressure 20.7 bar (300 psig) – adjusting pressure range 0 to 11 bar (0-160psi).



Part no.		Max. flow (l/min)	Dimensions (mm)	
			A	B
R21-C2-000-29	1/4" BSP	3 300 <sup>(1)</sup>	104	81
R21-C4-000-29	1/2" BSP	5 520 <sup>(1)</sup>	104	81
R21-C6-000-29	3/4" BSP	6 240 <sup>(1)</sup>	104	81
R31-C8-000-29	1" BSP	18 300 <sup>(2)</sup>	132	109
R31-CA-000-29	1 1/4" BSP	19 800 <sup>(2)</sup>	132	109
R41-CC-000-29	2" BSP	45 300 <sup>(2)</sup>	173	135

(1) At 6.9 bar (100 psig) inlet pressure. Secondary pressure of 6.0 bar (90 psig).  
 (2) At 6.9 bar (100 psig) inlet pressure. Secondary pressure of 5.5 bar (80 psig).  
 Operating temperature: 0 - 65°C.

## Chemical Dryer

- Polycarbonate bowl with metal guard.
- Dew point -43°.
- Desiccant regeneration +117°C.
- Desiccant replacement: **DRP-85-059** (pack of 8).

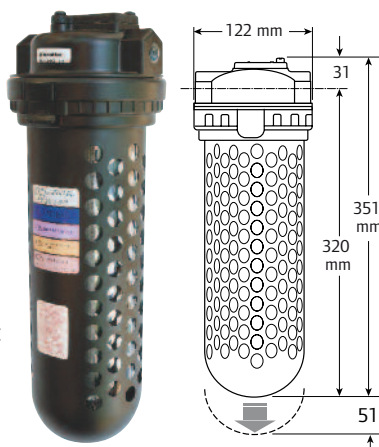

Part no.		Flow at 7 bar (l/s)	Max. pressure (bar)	Weight (kg) *
X03-C2-A29	1/4" BSP	4.7	10.3	3.4

\* With desiccant.

## Inline Lubricators

- Lubricator body from aluminium. Nitrile seals.
- Maximum inlet pressure 13.8 bar (200 psig).

**Intermittent lubricators:** oil is fed each time the air is turned on. They require cyclical or intermittent air flow for proper operation and work optimally when installed near the tool.



Part no.		Max. flow (l/min)	Bowl capacity (litre)	Weight (kg)
<b>Inline Lubricators / Constant Feed</b>				
L01-C2-A29	1/4"Fx1/4" F BSP	1000	0.007	0.10
L01-C2-E29	1/4"Fx1/4" M BSP	1000	0.007	0.10
L01-C3-A29	3/8"Fx3/8" M BSP	1000	0.007	0.10
8LUB16C-A3	1" F x 1" F BSP	9900	0.30	0.95
16LUB16C-A3	1" F x 1" F BSP	9900	0.56	2.00
<b>Inline Lubricators / Intermittent Feed</b>				
3LUB8	1/2"Fx1/2" F BSP	2820	0.11	0.45
6LUB12	3/4"Fx3/4" F BSP	2820	0.20	0.70
8LUB12-A3	3/4"Fx3/4" F BSP	4920	0.30	0.95
16LUB16-A3	1" F x 1" F BSP	9900	0.56	2.00

\* Max. operating temperature: 175° C

## Automatic Drains

- No electrical connection - easy to install.
- Quick disconnected clamp ring for easy bowl removal when servicing.
- Transparent bowl with metal guard as standard.
- Airline connection 1/2".

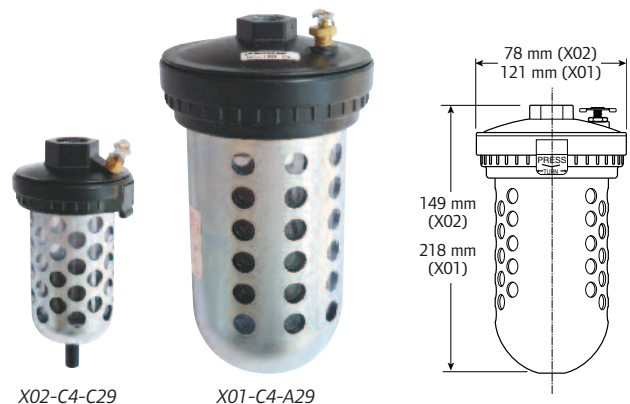

Part no.	Bowl capacity (ml)	Capacity at 6.9 bar (l/hr)	Max. pressure (bar)	Weight (kg)
X02-C4-C29	148	300	10.3	0.6
X01-C4-A29	950	570	10.3	2.1

# Fittings & Valves

## Reducing Nipples

Male-male reducing nipple – steel



Part no.	Ø M1	Ø M2	Quantity
36020	1/4"	1/8"	5
36011	1/4"	1/4"	5
36021	3/8"	1/4"	5
36012	3/8"	3/8"	5
36031	1/2"	1/4"	5
36022	1/2"	3/8"	5
36013	1/2"	1/2"	5
36023	3/4"	1/2"	5
36014	3/4"	3/4"	5
36024	1"	3/4"	5
36015	1"	1"	5

Male-female reducing nipple – steel

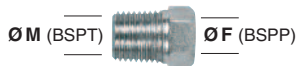

Part no.	Ø M	Ø F	Quantity
36040	1/4"	1/8"	5
36050	3/8"	1/8"	5
36041	3/8"	1/4"	5
36051	1/2"	1/4"	5
36042	1/2"	3/8"	5
36052	3/4"	3/8"	5
36043	3/4"	1/2"	5

Female-male reducing nipple – steel

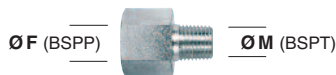

Part no.	Ø F	Ø M	Quantity
36060	1/4"	1/8"	5
36061	3/8"	1/4"	5
36062	1/2"	3/8"	5
36063	3/4"	1/2"	5

Female-female reducing nipple – steel



Part no.	Ø F1	Ø F2	Quantity
36080	1/4"	1/8"	5
36231	1/4"	1/4"	5
36081	3/8"	1/4"	5
36232	3/8"	3/8"	5
36082	1/2"	3/8"	5
36233	1/2"	1/2"	5
36083	3/4"	1/2"	5

BSPP = BSP parallel female thread.  
BSPT = BSP taper male thread.

## Male Ends

Steel



Part no.	Ø M	Ø H	Quantity
35006	1/4"	6	1
35007	1/4"	7	5
35008	1/4"	8	1
35010	1/4"	10	5
35012	1/4"	12	5
35013	1/4"	13	1
35107	3/8"	7	5
35108	3/8"	8	5
35110F	3/8"	10	5
35113	3/8"	13	1
36208	1/2"	8	1
36211	1/2"	11	1
36213	1/2"	13	1
36221	1/2"	16	5
36222	1/2"	19	5

Parkerised steel



Part no.	Ø M	Ø H	Quantity
<b>BSPT Thread</b>			
R-78	1/4"	7	5
R-108	1/4"	10	5
R-138	1/4"	13	5
R-1012	3/8"	10	5
R-1312	3/8"	13	5
R-1615	1/2"	16	5
R-1920	3/4"	19	5
R-2526	1"	25	5
<b>NPT Thread</b>			
RB-108	1/4"	10	5
RB-1312	3/8"	13	5
RB-1615	1/2"	16	5
RB-1920	3/4"	19	5

## Tool Regulator

Steel



Part no.	Dimensions
326-250	1/4" NPTF x 1/4" NPTM

## Swivel-It™ Universal Joints

Bi-directional 360° rotation, increases operator comfort and productivity.



Part no.	Dimensions	Maximum flow (l/s)
<b>Aluminium and Steel / Adjustable Flow</b>		
ASA-1/4	1/4" NPT	11.8
<b>Composite Material and Steel</b>		
ASC-1/4	1/4" NPT	15.5
<b>Aluminium and Steel</b>		
AS-3/8	3/8" NPT	21.2
AS-1/2	1/2" NPT	28.3

## Air Control Needle Valves

Composite material.  
Female threads.  
Maximum operating pressure: 13.8 bar.  
Operating temperature 0-90°C.







Part no.	Dimensions
104104-N02	1/4" NPT(F)
104104-N03	3/8" NPT(F)
104104-N04	1/2" NPT(F)
104104-N06	3/4" NPT(F)



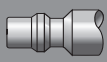

# Quick Release Couplings & Nipples







## IB Series tool couplings with composite material body

- High flow – up to three times more flow than ordinary brass coupling. Let your tool breathe for maximum performance !
- Up to 5 times longer leak-free life – sealed both at nose plug and on the valve.
- Durable, vibration absorbing body – to withstand installation directly at the tool.
- Shock proof and crash resistant – against mishandling.
- Made of non-marring composite – will not scratch your equipment.
- Antistatic and silicon free – ideal for use in paint shops.
- Increased convenience with button released couplings.
- Safety couplings allowing to bleed the hose prior to disconnecting.

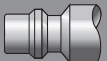
### ISO 6150B – MIL-C4109 Profile

 Bore Ø 6 mm (1/8")		Nipple (BSP)	Push-pull safety coupling Black body	Button / regular coupling Blue body/silver button	Button / safety coupling Black body/blue button
			<b>16 bar max. – Flow 15 l/s<sup>(1)</sup></b>	<b>12 bar max. – Flow 13 l/s<sup>(1)</sup></b>	
 Male thread	1/4" BSP	IB6NMC2	IBS6CCMC2	IBN6CMC2	IBS6CMC2
	3/8" BSP	IB6NMC3	IBS6CCMC3	IBN6CMC3	IBS6CMC3
	1/2" BSP	—	IBS6CCMC4	IBN6CMC4	IBS6CMC4
 Female thread	1/4" BSP	IB6NFC2	IBS6CCFC2	IBN6CFC2	IBS6CFC2
	3/8" BSP	IB6NFC3	IBS6CCFC3	IBN6CFC3	IBS6CFC3
	1/2" BSP	—	IBS6CCFC4	IBN6CFC4	IBS6CFC4
 For hose	Ø 6 mm	IB6NH06	—	IBN6CH06	IBS6CH06
	Ø 8 mm	IB6NH08	IBS6CCH08	IBN6CH08	IBS6CH08
	Ø 10 mm	IB6NH10	IBS6CCH10	IBN6CH10	IBS6CH10

 Bore Ø 8 mm (3/8")		Nipple (BSP)	Push-pull safety coupling Black body	Button / regular coupling Blue body/silver button	Button / safety coupling Black body/blue button
			<b>16 bar max. – Flow 30 l/s<sup>(1)</sup></b>	<b>12 bar max. – Flow 33 l/s<sup>(1)</sup></b>	
 Male thread	1/4" BSP	IB8NMC2	—	—	IBS8CMC2
	3/8" BSP	IB8NMC3	IBS8CCMC3	IBN8CMC3	IBS8CMC3
	1/2" BSP	IB8NMC4	IBS8CCMC4	IBN8CMC4	IBS8CMC4
 Female thread	1/4" BSP	IB8NFC2	—	—	IBS8CFC2
	3/8" BSP	IB8NFC3	IBS8CCFC3	IBN8CFC3	IBS8CFC3
	1/2" BSP	IB8NFC4	IBS8CCFC4	IBN8CFC4	IBS8CFC4
 For hose	Ø 8 mm	IB8NH08	IBS8CCH08	—	IBS8CH08
	Ø 10 mm	IB8NH10	IBS8CCH10	IBN8CH10	IBS8CH10
	Ø 13 mm	IB8NH13	IBS8CCH13	IBN8CH13	IBS8CH13

 Bore Ø 11 mm (1/2")		Nipple (BSP)	Push-pull safety coupling Black body	Bore Ø 11 mm (1/2")	Nipple (NPT)	Safety coupling Full Bore Steel	
			<b>16 bar max. – Rated flow 70 l/s<sup>(1)</sup></b>	<b>20 bar max. – Rated flow 71 l/s<sup>(1)</sup></b>			
 Male thread	3/8" BSP	IB11NMC3	IBS11CCMC3	 Male thread	3/8" NPT	23904-310.	—
	1/2" BSP	IB11NMC4	IBS11CCMC4		1/2" NPT	23904-410	23204-014
	3/4" BSP	—	IBS11CCMC6		3/4" NPT	—	23204-015
 Female thread	3/8" BSP	IB11NFC3	IBS11CCFC3	 Female Thread	3/8" NPT	23904-003	—
	1/2" BSP	IB11NFC4	IBS11CCFC4		1/2" NPT	23904-400.	23204-400.
	3/4" BSP	—	IBS11CCFC6		3/4" NPT	—	23204-005
 For hose	10 mm	IB11NH10	IBS11CCH10	 For hose	13 mm	23904-520.	23204-025
	13 mm	IB11NH13	IBS11CCH13		19 mm	—	23204-026
	16 mm	IB11NH16	IBS11CCH16				
	19 mm	IB11NH19	IBS11CCH19				



(1) Measured at 6 bar (87 psig) at inlet, with 10% pressure drop as per industry standard.



# Quick Release Couplings & Nipples



## EURO 7.2 - 7.4 Profile



Bore Ø7.2 7.4 mm		Nipple (BSP)	Push-pull regular coupling <small>Grey body</small>	Push-pull safety coupling <small>Black body</small>	Button / safety coupling <small>Black body/green button</small>
		16 bar max. – Flow 25 l/s <sup>(1)</sup>			12 bar max. – Flow 30 l/s <sup>(1)</sup>
 <b>Male thread</b>	1/4" BSP	77NMC2	7N7CCMC2	7S7CCMC2	7S7CMC2
	3/8" BSP	77NMC3	7N7CCMC3	7S7CCMC3	7S7CMC3
	1/2" BSP	77NMC4	7N7CCMC4	7S7CCMC4	7S7CMC4
 <b>Female thread</b>	1/4" BSP	77NFC2	7N7CCFC2	7S7CCFC2	7S7CFC2
	3/8" BSP	77NFC3	7N7CCFC3	7S7CCFC3	7S7CFC3
	1/2" BSP	77NFC4	7N7CCFC4	7S7CCFC4	7S7CFC4
 <b>For hose</b>	Ø 6 mm	77NH06	7N7CCH06	7S7CCH06	—
	Ø 8 mm	77NH08	7N7CCH08	7S7CCH08	7S7CH08
	Ø 10 mm	77NH10	7N7CCH10	7S7CCH10	7S7CH10
	Ø 13 mm	77NH13	7N7CCH13	7S7CCH13	7S7CH13





## ARO Profile



Bore Ø 6 mm (1/4")		Nipple (BSP)	Button / regular coupling (BSP) <small>Grey body/gold button</small>	Button / safety coupling (BSP) <small>Black body/yellow button</small>	Nipple (NPT)	Regular coupling (NPT) <small>Steel</small>
		12 bar max. – Flow 17 l/s (standard) - 13 l/s (safety) <sup>(1)</sup>			20 bar max. – Flow 8.5 l/s <sup>(1)</sup>	
 <b>Male thread</b>	1/4"	AN6CMC2	AN6CMC2	AS6CMC2	2608	210-212.
	3/8"	AN6CMC3	AN6CMC3	AS6CMC3	—	210-213.
	1/2"	—	AN6CMC4	AS6CMC4	—	—
 <b>Female thread</b>	1/4"	AN6CMFD2	AN6CFC2	AS6CFC2	2609.	210-B
	3/8"	AN6CMF3	AN6CFC3	AS6CFC3	—	—
	1/2"	—	AN6CFC4	AS6CFC4	—	—
 <b>For hose</b>	6 mm	AN6CH06	AN6CH06	AS6CH06	39046.	210-022.
	8 mm	AN6CH08	AN6CH08	AS6CH08	39047.	—
	10 mm	AN6CH10	AN6CH10	AS6CH10	22238	210-215.

## 1300/1800 Profile



		Nipple (BSP)	Regular coupling <small>Steel</small>			Nipple (BSP)	Regular coupling <small>Steel</small>
		30 bar max. – Flow 23 l/s <sup>(1)</sup>				30 bar max. – Flow 61 l/s <sup>(1)</sup>	
 <b>Male thread</b>	1/4" BSP	13210N	—	 <b>Male thread</b>	1/4" BSP	18110	—
	3/8" BSP	13220	1300A		3/8" BSP	18210N	—
	1/2" BSP	13410	1300		1/2" BSP	18220	1800A
 <b>Female thread</b>	3/8" BSP	—	1300B	3/4" BSP	18230	—	
	6 mm	13006	1300 + 1306 <sup>(2)</sup>	1/4" NPT	18405	—	
	8 mm	13008	1300 + 1308 <sup>(2)</sup>	3/8" NPT	18410	1800	
 <b>For hose</b>	10 mm	13010	1300 + 1310 <sup>(2)</sup>	1/2" NPT	—	1800B	
	12 mm	13012	1300 + 1312 <sup>(2)</sup>	3/4" NPT	—	1800C	
				6 mm	18006	—	
				8 mm	18008	—	
				10 mm	18010	1800 + 1810 <sup>(2)</sup>	
				12 mm	18012	1800 + 1812 <sup>(2)</sup>	
			16 mm	18016	1800 + 1816 <sup>(2)</sup>		
			19 mm	18019	1800 + 1819 <sup>(2)</sup>		



(1) Measured at 6 bar (87 psig) at inlet, with 10% pressure drop as per industry standard.

(2) Nipples to allow installation of a coupling onto a hose (see illustration above).

# Hoses - Mufflers - Blow Guns

## Recoil Hoses & Hose Coils

The Ingersoll Rand line of hoses are pressure rated for optimised pneumatic performance, even in the toughest shop environments and applications.

### Polyurethane Recoil Hoses

Part no.	Hose int. diameter (mm)	Male fittings: NPT thread (in)	Hose length (m)	Working length (m)	Compact length (m)
<b>Yellow Hose</b>					
34102	6	1/4	3	2.5	0.15
34202	6	1/4	6	5	0.31
34302	6	1/4	9	8	0.43
35102	8	1/4	3	2.5	0.14
35202	8	1/4	6	5	0.30
35302	8	1/4	9	8	0.46
IR36103	9.5	1/4	3	2.5	0.15
IR36203	9.5	1/4	6	5	0.34
IR36303	9.5	1/4	9	8	0.52
IR36102	9.5	3/8	3	2.5	0.15
IR36202	9.5	3/8	6	5	0.34
IR36302	9.5	3/8	9	8	0.52
IR37102	13	1/2	3	2.5	0.16
IR37202	13	1/2	6	5	0.38
<b>Blue Hose</b>					
IR36713	9.5	3/8	6	5	0.34
IR36715	9.5	3/8	9	7.5	0.52

\* Temperature range -40 to +38°C. Operating pressure 8 bar at 24°C.

### Nylon Recoil Hoses

Part no.	Hose int. diameter (mm)	Male fittings: NPT thread (in)	Hose length (m)	Working length (m)	Compact length (m)
<b>Red Hose</b>					
12-20301	6	1/4	3.5	3.0	0.15
12-20302	6	1/4	7.5	6.5	0.31
33130	6	Without fittings	30	27	1.15
12-20307	8	1/4	3.5	3.0	0.15
12-20308	8	1/4	7.5	6.5	0.23
12-20313	9.5	1/4	3.5	3.0	0.13
12-20314	9.5	1/4	7.5	6.0	0.25
12-20319	9.5	3/8	7.5	6.0	0.25
33230	9.5	Without fittings	30	26	0.97
12-20324	13	1/2	3.5	2.7	0.13
12-20325	13	1/2	7.5	5.5	0.23
33330	13	Without fittings	30	23	0.89
33410	19.5	3/4	7.5	5.2	0.23
12-20332	19.5	3/4	15	10.7	0.41
33430	19.5	Without fittings	30	21.5	0.79
33530	25.4	Without fittings	30	19.8	0.87

\* Temperature range -25 to +75°C. Operating pressure 13 bar at 20°C.

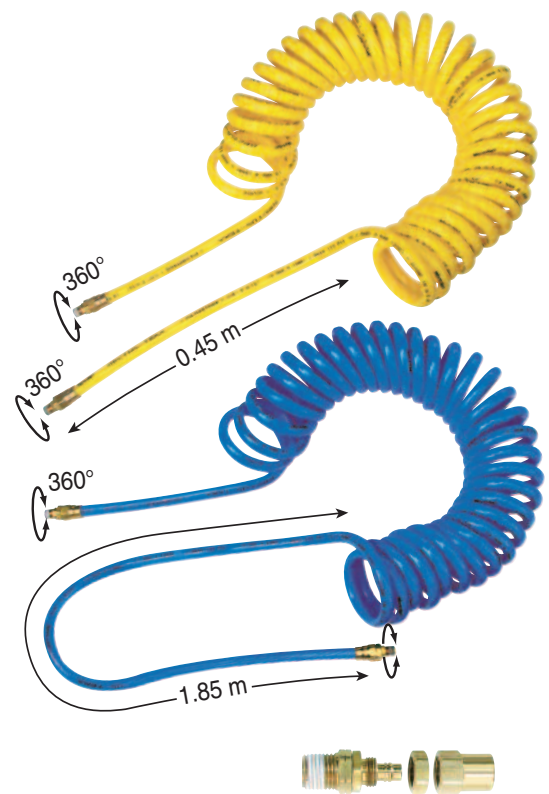

### Fittings Kits for Polyurethane Hoses

Part no.	Thread size (in)	Hose internal Ø (mm)
06368	1/4	6
06369	1/4	8
06370	3/8	9.5
06372	1/2	13

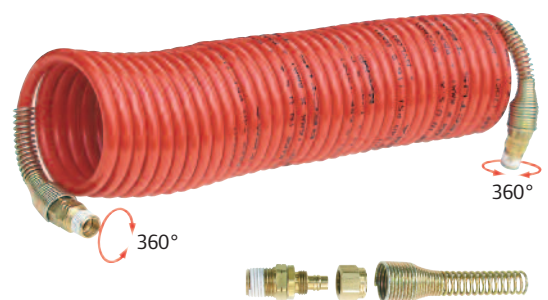

### Fittings Kits for Nylon Hoses

Part no.	Thread size (in)	Hose internal Ø (mm)
33002	1/4	6
330025	1/4	8
33008	1/4	9.5
33003	3/8	9.5
33004	1/2	13
33005	3/4	19.5
33006	3/4	25.4
33007	1	25.4

# Hoses - Mufflers - Blow Guns



## High Quality PVC Round Hose, 30 m Coil

- Scuff resistant outer cover – great kink resistance.
- Lightweight and ultra flexible.
- Resistance against a wide range of chemicals.
- Temperature range from -20 to +65°C.



Part no.	Internal diameter (mm)	External diameter (mm)	Burst pressure (bar)	Working pressure at 20°C * (bar)
RH-6	6	11	74	18
RH-8	8	13	65	15
RH-10	10	14	54	13
RH-12	13	17	44	11
RH-16	16	21	44	11
RH-19	19	24	44	11

\* Safety factor 4:1.

## Mufflers

- Effective sound attenuation for low noise level.
- Low back pressure provides minimal power loss.



Part no.	NPT thread (in)	Flow capacity	Body diameter (mm)	Overall length (mm)
MRV003A010-RP	1/8	Medium	54	36
MRV015A010-RP	1/4	High	64	40
MRV040A010-RP	1/2	Medium	79	52
MOV010AA-674	1/2	High	68	87
3BM-WM07	3/4	Medium	182	56
3BM-A674	1	High	220	98
150BM-A674	1 1/4	High	107	85
SS350-A674	1 1/2	High	116	84
ST500-674	2	Medium	122	70
SS800-A674	2 1/2	High	169	121



## Hose Whips

Part no.	Thread size (in)	Hose length (mm)
33104	1/4 NPT	300
33204	3/8 NPT	300
33304	1/2 NPT	300

## Hose Clamps



Part no.	Hose external diameter (mm)	Packing quantity
CO-0911	9-11	100
CO-1113	11-13	100
CO-1315	13-15	100
CO-1518	15-18	100
CO-1821	18-21	100
CO-2225	22-25	100

## Safety Blow Guns

OSHA compliant with outlet pressure reduced to 2 bar for increased operator safety.

### Part no. 94053

Brass air screen tip produces conical air stream around direct centre air stream – minimises blow-back of chips or particles. Maximum air pressure 6-7 bar. 1/4" BSP inlet. Weight 200 gr.



### Part no. 94054

For use with blow pipes only. Maximum air pressure 6-7 bar. 1/4" BSP inlet. Weight 190 gr.

- Blow pipe, 150 mm long, part no. 94055
- Blow pipe, 450 mm long, part no. 94056

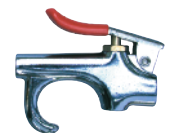

### Part no. 94057

One piece, die cast construction. Tamper-proof vent holes increase total air flow. Maximum air pressure 6-7 bar. 1/4" BSP inlet. Weight 190 gr.



### Part no. 94058

Safety blow gun in composite material with built-in blow pipe. Maximum air pressure 10 bar. 1/4" BSP inlet. Maximum air flow 6.4 l/s



Distributed by:

[www.AROzone.com](http://www.AROzone.com)

[arotechsupport@irco.com](mailto:arotechsupport@irco.com)

[youtube.com/aropumps](https://youtube.com/aropumps)

(800) 495-0276

# ARO®

ARO® is a brand of Ingersoll Rand. Ingersoll Rand (NYSE:IR) advances the quality of life by creating comfortable, sustainable and efficient environments. Our people and our family of brands—including Club Car®, Ingersoll Rand®, Thermo King® and Trane®—work together to enhance the quality and comfort of air in homes and buildings; transport and protect food and perishables; and increase industrial productivity and efficiency. We are a \$13 billion global business committed to a world of sustainable progress and enduring results. For more information, visit [www.ingersollrand.com](http://www.ingersollrand.com).